

ULTRA SAUNA HEATER INSTALLATION GUIDE

Gas Heaters - 40,000-80,000 BTU

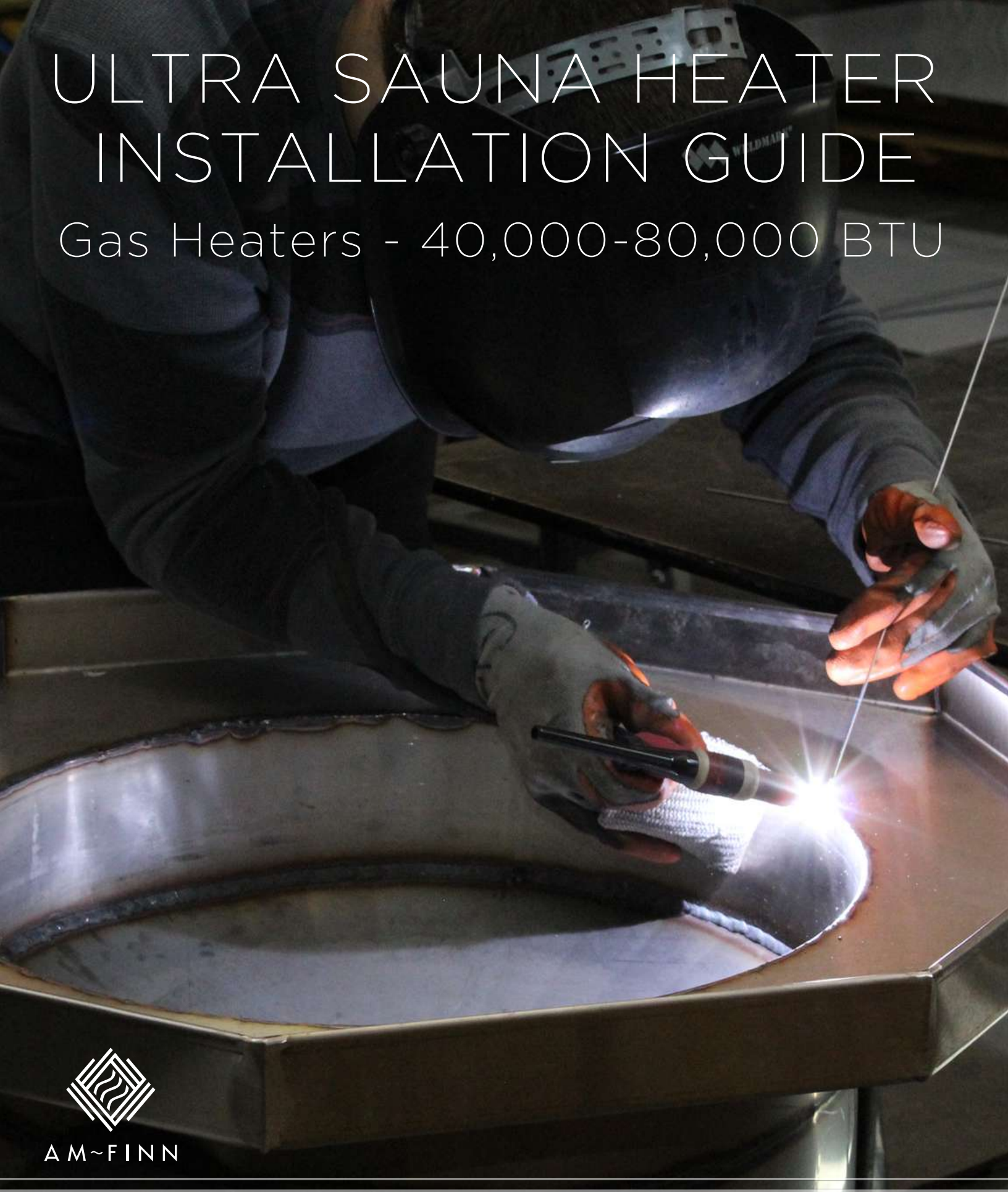

AM~FINN

TABLE OF CONTENTS

1. Disclaimer	3
2. Gas Consumption information	4
3. Gas Sauna Heater Order Form	5
4. Safety Warning	6
5. Before You Start Please Read Carefully	7
6. Heater Component List	8
7. Your Heater Should Include	9
8. Heater Sizing	9
9. Sauna Heater Sizing	10
10. Rough-in Sizing guidelines	11
11. Rough-in control box and interior back panel	13
12. View - Exterior View	15
13. Finishing the sauna room	16
14. Scandia Ultra-Sauna Heater Guard Rail	17
15. Gas Burner Overview - Standing Pilot Version	18
16. Piezo Ignitor Overview	18
17. Pilot Light Warning	19
18. 60 Minute Control Wiring Overview	20
19. 24 Hour Control Wiring Overview	20
20. Sauna Maintenance	21
21. Heater Care	21
22. Ultra Sauna - Warranty	22
23. Gas Heater - Technical Service Ticket	23
24. Troubleshooting guidelines - Gas Fired Heaters	24
25. Gas Heaters and burner maintenance guidelines	26

Congratulations on purchasing your Scandia Ultra-Sauna gas fired heater! Since 1964, Scandia Manufacturing has been making the best sauna heaters in the industry. Each heater is hand crafted and individually made by an expert technician. They are not mass-produced; we consider each heater a work of art.

To ensure your satisfaction with our heater we suggest you read through this guide and familiarize yourself with:

1. Installation Instructions
2. Gas Heater Component List
3. Warranty Information
4. Troubleshooting Guide

Safety First

You must consult a certified plumber or HVAC professional to assist you with regulating gas line pressure, installation and connection of your Scandia Ultra-Sauna. Self-installations will void your warranty. When you receive your heater you should inspect it within 48 hours to verify all parts, materials and instructions are there. Scandia is not responsible for replacing or warranting items that are not reported within 5 days of receipt of your shipment.

If your shipment is damaged please retain all packaging and call us immediately

3

Prior to installation, the installer (certified professional) should check all connections and parts to ensure proper fitting. These items may have come loose in shipping. You can rest assured knowing that your unit was fired and tested in our production facility prior to shipping to ensure proper working order. Loose connections and/or improper installation are the most common reasons for your unit not firing up right away. Do not call the manufacturer until a licensed professional has checked to ensure proper connection.

The heater must be installed with a heater guard rail – see instruction for proper clearances.

Your heater comes standard with a flue cap (for through-wall venting) or an elbow and draft-hood (for through-ceiling venting). We recommend one 90 degree turn in venting if needed as additional turns can cause heat to become trapped in the unit itself and result in improper functioning of the heater. Straight through the wall venting (flue cap) typically does not use an elbow and it is not recommended unless approved by a certified professional. We highly recommend consulting with a venting specialist or engineer if you are planning venting runs longer than 7 feet as this may require a power vent.

Scandia is not a venting company. Please consult a venting specialist for your venting needs.

Caution signs are included for your safety.

Maximum recommended ceiling height is 7 feet.

GAS CONSUMPTION INFORMATION FOR SCANDIA ULTRA-SAUNA

The gas consumption for the Ultra-Sauna heater can be different for every room and will vary depending on the following conditions:

- Properly built sauna room
- Seven foot ceiling height
- Adequate room insulation
- All cedar wood interior
- Tightly fitting door
- Outside (for outdoor saunas) temperature 50 deg F or higher
- Correct heater sizing
- Correct heater venting configuration

The heater will perform as follows:

4

- Heat the room to temp (170-185 deg F) within 30-60 minutes
- After reaching temp (with minimal door traffic) the heater should maintain that temp on a 50% on/off basis.
- A one hour run -time should result in 25-40 minutes of heater run time.
- Door traffic, outside temp and other conditions listed above will influence efficiency.

Calculation notes to reference against local utility pricing:

1 BTU = 0.03 Watt hours
100,000 BTUs = 1 therm

Please provide this information to your local gas supplier and they will be able to provide you with the gas consumption calculations for your sauna room.

Sincerely,

Scandia Manufacturing
Technical Dept

GAS SAUNA HEATER ORDER FORM

(This Form must be included with each gas heater order)

The following information is necessary when ordering a gas heater.

Customer Name/Project Name: _____

1. Size of the sauna room including height: _____ L X _____ W X _____ H

2. Wall Composition:

•Framing Material: _____ Type of Insulation: _____

•Interior Finish (Material) _____ Exterior Finish (Material) _____

3. The sauna room must be vented to the outside, not inside the sauna. How will it be vented (circle one)?

• Is it vented out the back wall? Horizontally, Flue cap attachment (240/280 models)

• Is it vented out the back wall? Vertically, elbow/drafthood attachments (245/285 models)

5

4. Natural Gas or Liquid Propane (choose one): _____

5. 60 Minute Timer or 24 Hour Commercial Timer: _____

NOTE: 60-min timer is standard. 24-hour is for commercial use only and is available at additional cost.

6. Thickness of exterior wall: _____

NOTE: A set of extensions must be purchased for walls thicker than 5 1/2

7. What is the elevation above sea level?

NOTE: Location where the heater will be installed

• What is the gas line pressure?

NOTE: Standard gas lines are 3-1/2" water column for Natural Gas and 1" for LP (Propane).

Natural gas requires a minimum 1/8 lb PSI, maximum 1/2 lb PSI.

8. Style of burner: Standing Pilot or Electronic PIEZO Style (upgrade): _____

NOTE: Standard burner comes with standing pilot generator. Upgrade to PIEZO style burner is available for an additional cost.



WARNING

IF THESE INSTRUCTIONS ARE NOT FOLLOWED EXACTLY, A FIRE OR EXPLOSION MAY RESULT, CAUSING PROPERTY DAMAGE, PERSONAL INJURY, OR DEATH.

FOR YOUR SAFETY: This product must be installed and serviced by a contractor who is licensed and qualified in HVAC equipment by the jurisdiction in which the product will be installed where such state or local requirements exist. In the event no such state or local requirement exists, the installer or maintainer must be a professional with sufficient experience in pool equipment installation and maintenance so that all of the instructions in this manual can be followed exactly. Before installing this product, read and follow all warning notices and instructions that accompany this product. Failure to follow warning notices and instructions may result in property damage, personal injury, or death. Improper installation and/or operation can create carbon monoxide gas and flue gases which can cause serious injury, property damage, or death. For indoor installations, as an additional measure of safety, Scandia Manufacturing strongly recommends installation of suitable carbon monoxide detectors in the vicinity of this appliance and in any adjacent occupied spaces. Improper installation and/or operation will void the warranty.

Do not store or use gasoline or other flammable vapors and liquids in the vicinity of this or any other appliance.

WHAT TO DO IF YOU SMELL GAS

- Immediately switch off main gas supply.
- Do not try to light any appliance.
- Do not touch any electrical switch; do not use any phone in your building.
- Immediately call your gas supplier from a neighbor's phone. Follow the gas supplier's instructions.
- If you cannot reach your gas supplier, call the fire department.

Installation and service must be performed by a qualified installer, service agency or the gas supplier.

This appliance needs fresh air for safe operation and must be installed so there are provisions for adequate combustion and ventilation air.

WARNING: Operation of this furnace when not connected to a properly installed and maintained venting system can result in Carbon Monoxide (C.O.) poisoning and possible death.

WARNING: Operation of this appliance when not connected to a properly installed and maintained venting system or tampering with the vent safety shutoff system can result in Carbon Monoxide (C.O.) poisoning and possible death.

6



WARNING

Outline of Lighting Instructions for Appliances Equipped with and Intermittent Pilot or Interrupted Pilot System

1. Turn gas valve knob to the "Pilot" position.
2. Press knob in and hold
3. With knob pressed in, using a lighting device, place flame under the hood of the pilot
4. Once pilot ignites, release the knob
5. Turn knob to the "on" position

BEFORE YOU START PLEASE READ CAREFULLY

- Heater and controls must be installed by a licensed professional.
- Heater must be vented to the outside of the sauna. Please consult a licensed professional for ventilation requirements in your area.
- Heater controls must never be installed inside the sauna room.
- Heater controls should never be placed near water.
- Heater must be installed according to local codes.
- Ensure all factory connections are tight. Wires may have come loose in shipping.
- Heater should not be operated without recommended amount of rocks.
- Sauna door must always open outward.
- Sauna door can never include a lock.
- Sauna should be constructed of soft wood (i.e. clear western red cedar).
- Sauna room should never have tile walls or benches.
- Do not treat or varnish sauna wood.
- Use only Scandia high density sauna rocks.
- The warning signs and sauna usage plaque must be displayed.
- Sauna room sizing is based on standard 7 foot ceiling.
- Do not touch the heater while in operation.
- Do not cover the heater.
- Never hose down the sauna.
- Never leave children unattended.
- Sauna bathing is not suitable for those with health problems.
- Sauna room must be vented according to manufacturers specifications or Scandia installation instructions.
- Heater guard must be installed.

HEATER COMPONENT LIST

- ① Heater body unit
- ② Back panel w/external through-wall covers
- ③ Stainless steel flashing (internal back panel cover)
- ④ Venting component option (flue cap or draft hood)
- ⑤ Complete burner assembly (natural gas or propane)
- ⑥ Control box with cover, wires, knobs
- ⑦ Imported high-density sauna rocks

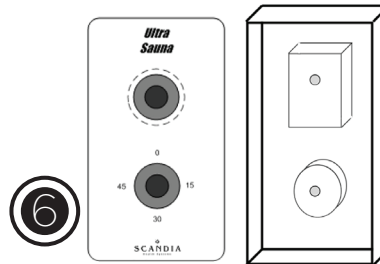
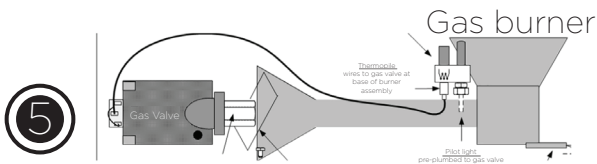
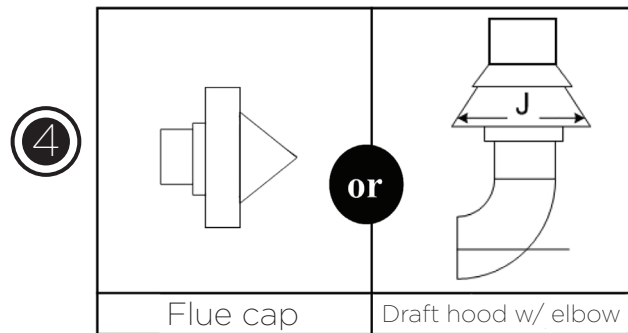
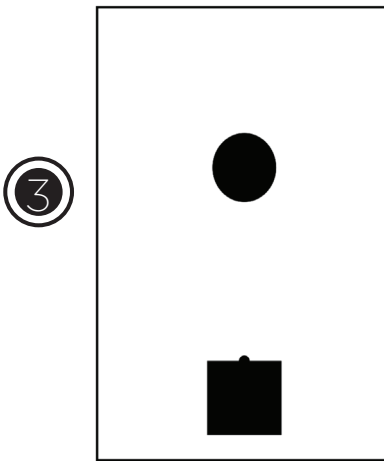
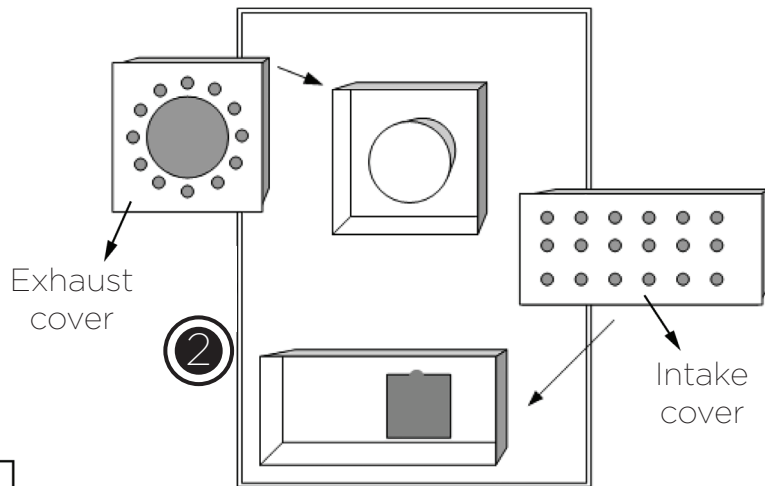

YOUR HEATER SHOULD INCLUDE

- Control Panel
- Main Heater Unit
- Sauna Rocks
- Thermostat sensor wall cover - No picture
- Sauna rock plate
- Installation Instructions
- Warning Signs - No picture
- Back panel assembly
- Back panel flashing
- Flue cap or elbow/draft hood set

HEATER SIZING

Ultra Sauna Gas Fired Heaters			
Model	BTU Output	Minimum Room Size	Maximum Room Size
240	40,000 BTU	84 cu ft (25.6 cu m)	616 cu ft (187.76 cu m)
245	40,000 BTU	84 cu ft (25.6 cu m)	616 cu ft (187.76 cu m)
280	80,000 BTU	450 cu ft (137.16 cu m)	1680 cu ft (512.01 cu m)
285	80,000 BTU	450 cu ft (137.16 cu m)	1680 cu ft (512.01 cu m)

9

Warranty Disclaimer - Not valid if room is over 8ft.

SAUNA HEATER SIZING

- Minimum and maximum room sizes are based on a 7 foot ceiling height
- Properly sized heater will bring room temperature to desired level in approximately 30 to 60 minutes
- An undersized heater may experience instances of the heater unit overheating and a longer time to bring the room up to temperature
- Sauna room must be properly vented for heater to work effectively
- Temperature range 170-185 deg F

ROUGH-IN SIZING GUIDELINES

NOTE: Your scandia ultra gas sauna heater should be installed only by a licensed electrician and HVAC professional. Improper or unofficial installation will void warranty.

	40,000 BTU	80,000 BTU
A	18.5"	29"
* B	8"	12"
* C	7"	11"
D	2 1/2"	4"

* Minimum clearance

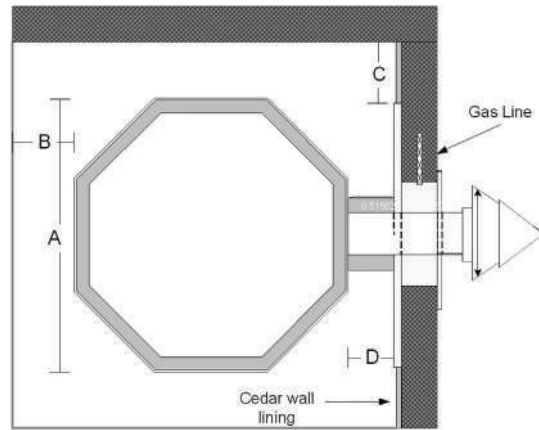

ROUGH-IN SIZING

MODELS	HEATER	A	B	C	D	E	F	G	H	I	J	K	L	N
240 & 245	40,000	28"	4"	18 1/2"	2 1/2"	20" X 32"	8 1/4" X 13 1/4"	3 1/2"	24 1/2"	14"	7"	4"	10 1/4"	8"
280 & 285	80,000	40"	6"	29"	4"	33" X 45"	8 1/4" X 16 1/4"	5 1/2"	32"	20"	12"	6"	12 1/4"	14"

10

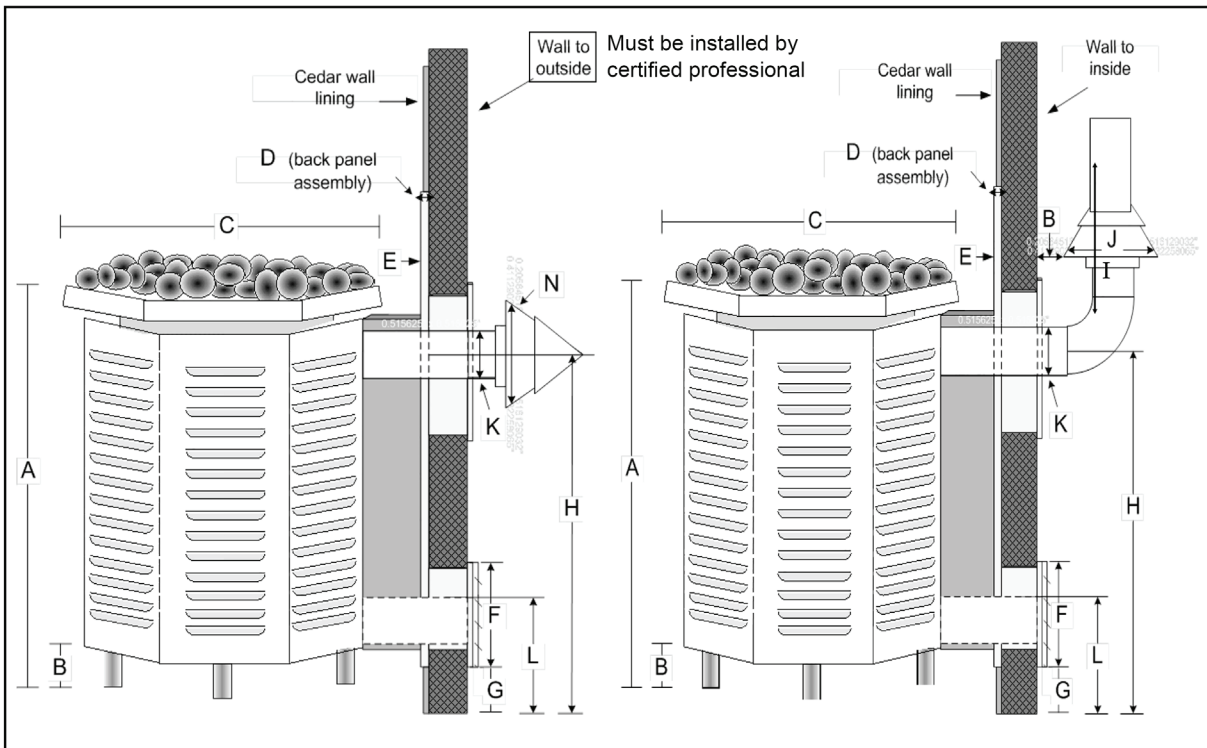

ROUGH-IN CONTROL BOX AND INTERIOR BACK PANEL

40,000 BTU Heater (240/245)

Installing the back panel

- Back panel should be installed when sauna room is framed in prior to the finishing steps of the sauna room
- Back panel is mounted directly to the face of the studs
- Insulate area between back panel and exterior wall in accordance with local codes
Centerline of the flue opening must be a minimum of 17 1/2" from the side wall.
- Metal tabs at the bottom of the back panel must rest on the finished floor.
- If the interior wall material is more than 3/4" thick spacers should be placed between the stud and the back panel
- Adjust intake box and flue collar to wall thickness. Walls thicker than 5 1/2" will require extensions

11

Installing the control box

- Control box should be installed when sauna room is framed in prior to the finishing steps of the sauna room
- Control box is mounted to the studs facing outside the room at the farthest point away from the heater
- Control box should be 42" from the floor to center of the timer knob
- Place a nail 10" below the interior ceiling on the stud facing the sauna room. String a pull wire from the nail to the control box.
- 25 feet of low voltage two lead wire is supplied in the control box. Run this wire from the control box to the heater intake box and through the opening in the side of the box

80,000 BTU Heater (280/285)

Installing the back panel

- Back panel should be installed when sauna room is framed in prior to the finishing steps of the sauna room.
- Back panel is mounted directly to the face of the studs.
- Insulate area between back panel and exterior wall in accordance with local code.
- Centerline of the flue opening must be a minimum of 26 1/2" from the side wall.
- Metal tabs at the bottom of the back panel must rest on the finished floor.
- If the interior wall material is more than 3/4" thick spacers should be placed between the stud and the back panel.
- Adjust intake box and flue collar to wall thickness. Walls thicker than 5 1/2" will require extensions.

Installing the control box

12

- Control box should be installed when sauna room is framed in prior to the finishing steps of the sauna room.
- Control box is mounted to the studs facing outside the room at the farthest point away from the heater.
- Control box should be 42" from the floor to center of the timer knob.
- Place a nail 10" below the interior ceiling on the stud facing the sauna room. String a pull wire from the nail to the control box.
- 25 feet of low voltage two lead wire is supplied in the control box. Run this wire from the control box to the heater intake box and through the opening in the side of the box.

Placing Sauna Rocks

- Wash rocks with water before placing in sauna.
- Insert rock plate in heater cone/basin before loading rocks into sauna.

VIEW-EXTERIOR VIEW

40,000 BTU HEATER (240/245)

THROUGH WALL ROUGH-IN:

- A) Exhaust vent (9 in x 9 in)
- B) Intake vent (13 1/8 in X 8 1/4 in)
- C) Please allow 1/4 inch tolerance in these dimensions.

After intake and exhaust openings are roughed in, and interior back panel is installed, place flue collar in the exhaust vent opening adjusting to the wall thickness.

Repeat with intake box cover.

Walls thicker than 5 1/2 inches will require extensions.

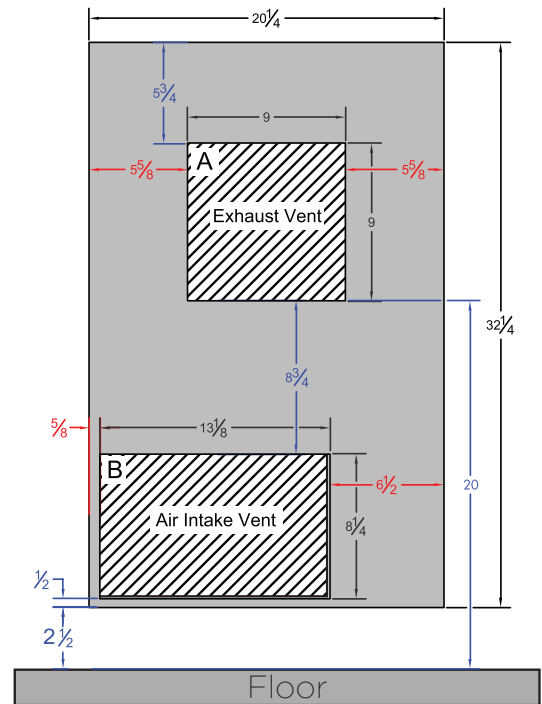

13

80,000 BTU HEATER (280/285)

THROUGH-WALL ROUGH-IN:

- A) Exhaust vent (12 1/2 in X 12 1/4 in)
- B) Intake vent (16 1/2 in X 8 1/4 in)
- C) Please allow 1/4 inch tolerance in these dimensions.

After intake and exhaust openings are roughed in, and interior back panel is installed, place flue collar in the exhaust vent opening adjusting to the wall thickness.

Repeat with intake box cover.

Walls thicker than 5 1/2 inches will require extensions.

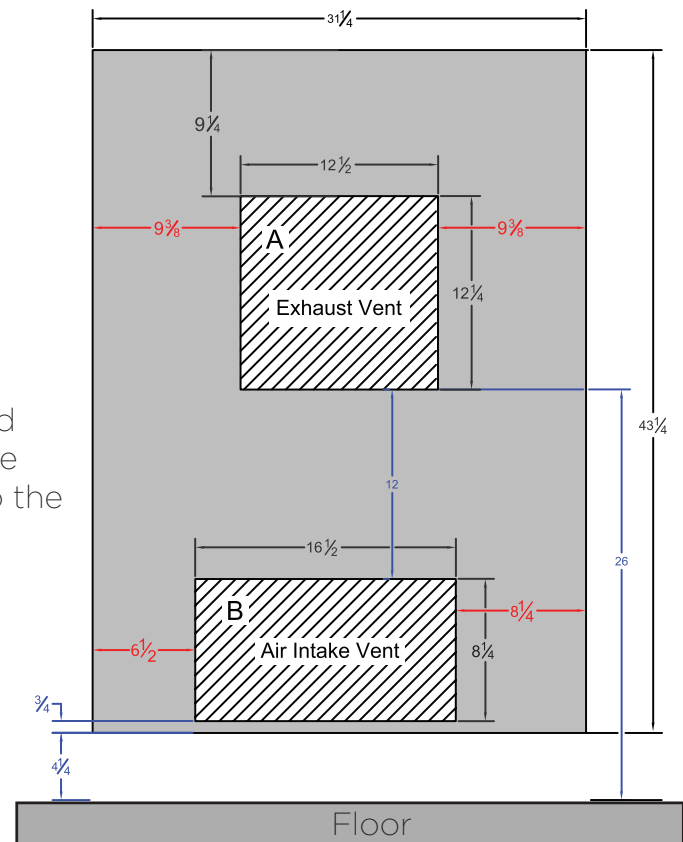

FINISHING THE SAUNA ROOM

Finish

1. Insulate the space between the backpanel and the exterior wall per local codes
2. Ensure wall material rests behind the lip on the back panel
3. Place 1" fiberglass insulation against the interior side of the back panel
4. Remove paper from stainless flashing and start screws to galvanized (do not tighten)
5. Remove butterfly nut from bottom of intake box and slide burner assembly out of the unit.
6. Slide heater into place, guide insulated high-limit wires through the hole on the intake bracket. Secure heater to stainless steel flashing with two screws.
7. Tighten screws on the corners of the flashing.
8. Slip burner inside heater through the intake box allowing the burner lip to fit under the burner bracket. Replace the butterfly nut and screw to secure the burner.
9. Place caution sign on flashing above heater.
10. Carefully uncoil the thermostat probe and using the pull wire previously placed gently pull the probe into the sauna room.
11. Attach the thermostat probe ten inches below ceiling as far away from heater as possible. The probe must be placed horizontally in the provided thermostat probe cover.
12. Install heater guard rail.

14

	CHASSIS	240/245	280/285
A	Width Of Heater Shell	18 1/2"	29"
	Wall to Face of Heater	21"	33"
B	Side of Heater to Wall (Min.)	8"	12"
	Height of Heater Shell	28"	40"
	Wall to Inside of Guard (Min.)	29"	41"
	Floor to Bottom of shell	4"	6"

SCANDIA ULTRA-SAUNA HEATER GUARD RAIL



Components for 3-sided heater guard	Heater guard rail installation
<ul style="list-style-type: none"> ● 2x 2x2 corner posts / legs ● 3x 1x4 rails long piece rails for front ● 6x 1x4 short piece rails for each side ● 2x Wall brackets <p>Misc. screws</p> <p>** 2-sided heater guard will have 1 post and one side only.**</p>	<ul style="list-style-type: none"> ● All components come ready to be assembled ● Observe distances a round heater for guard rail, walls, benches and other obstructions ● Follow the heater manufacturer's clearances recommendations. ● Do not cut down heater guard to fit!

GAS BURNER OVERVIEW-STANDING PILOT VERSION

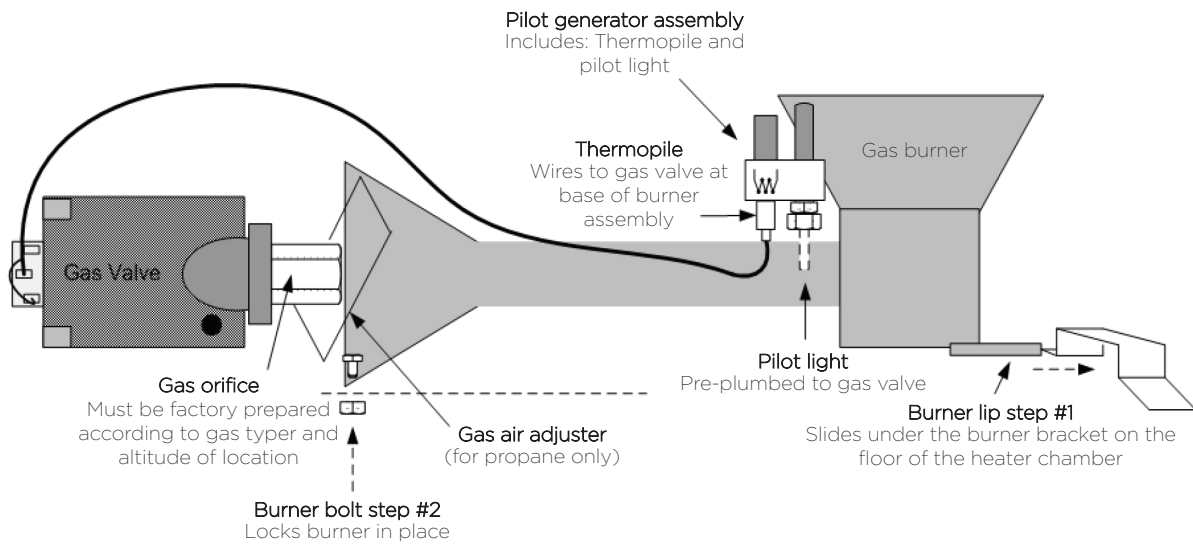

Burner installation

- 1- Burner lip must be inserted into the burner bracket on the inside base of the heater chamber.
- 2- Bolt the burner to the intake vent floor- use the pre-drilled hole.

PIEZO IGNITOR OVERVIEW

Wiring schematic for piezo ignition-scandia/vico ultra gas sauna heater

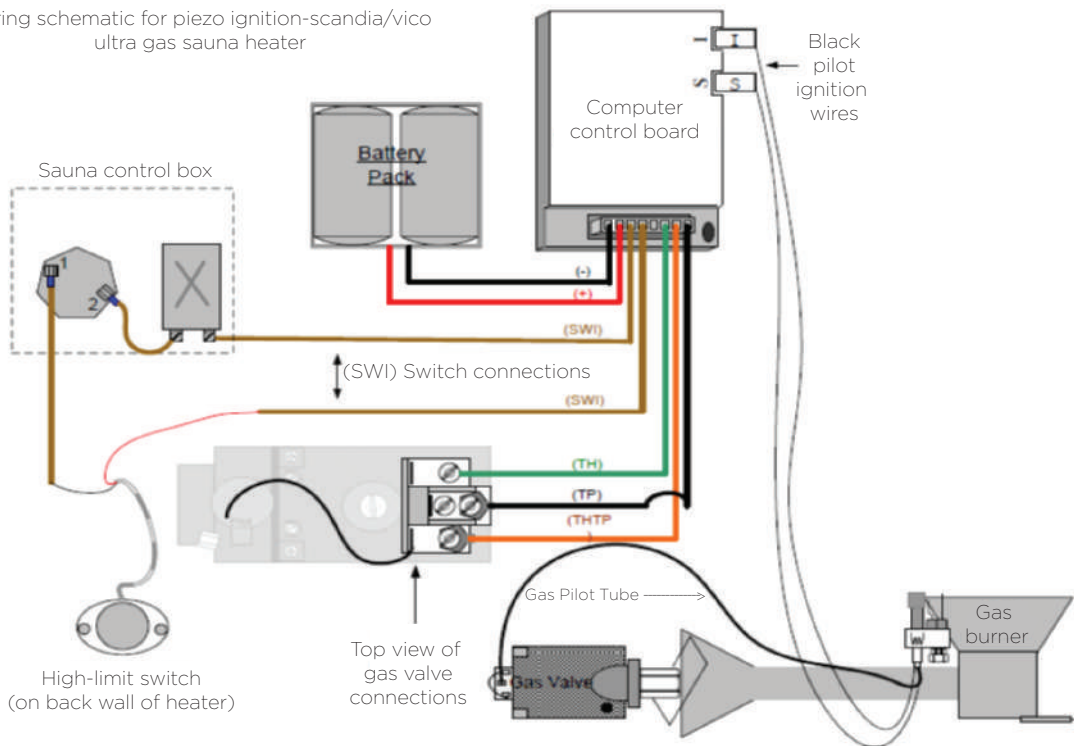

60 MINUTE CONTROL WIRING OVERVIEW

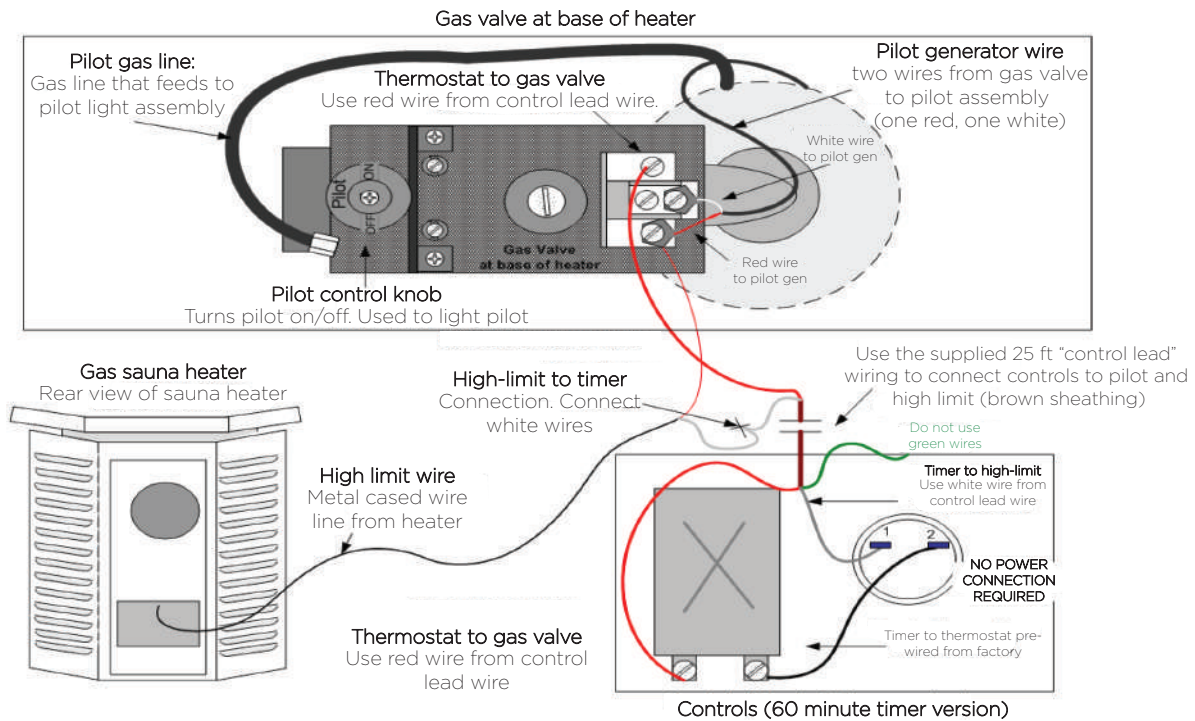

24 HOUR CONTROL WIRING OVERVIEW

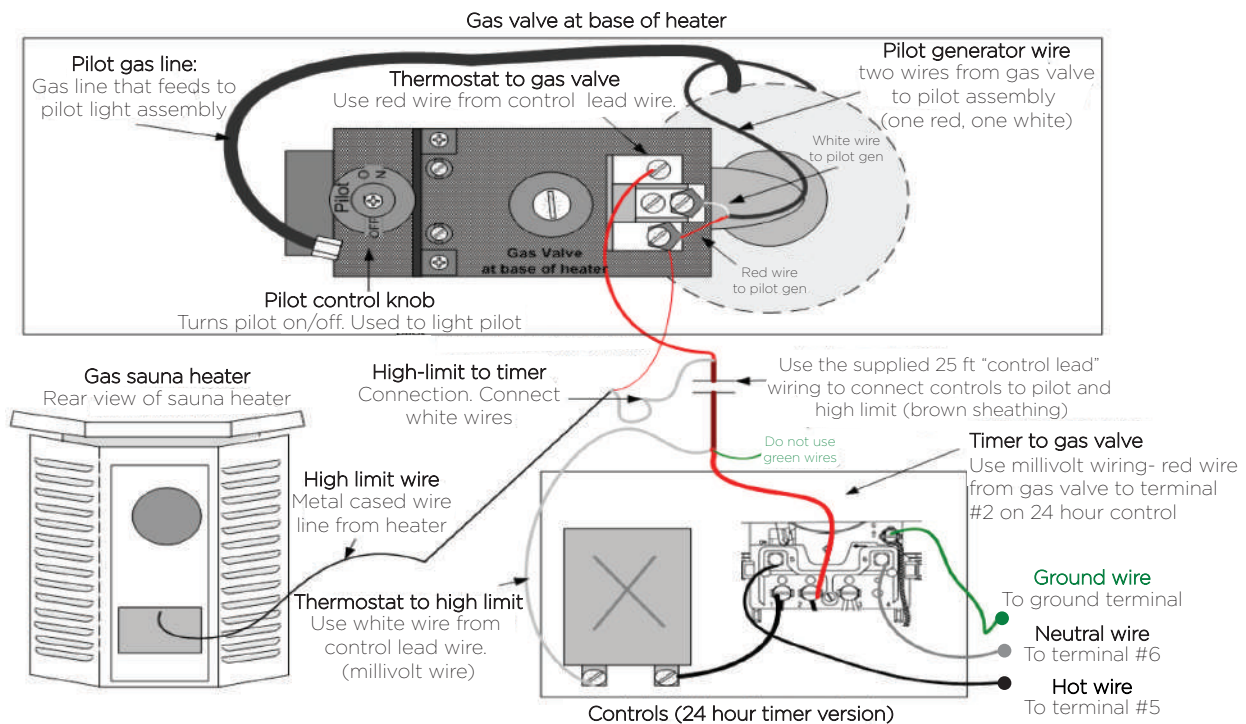

SAUNA MAINTENANCE

Daily

- Wait for the sauna to cool before entering the sauna to conduct a cleaning.
- Use a bucket of warm water with a mild detergent (a liquid soap is sufficient) and clean sponge or rag to wipe the bench surfaces.
- Do not use petroleum-based detergents. They can discolor your wood and will leave a residue which could emit irritating fumes.
- Wet mop the tile or cement floor.
- If something unpleasant other than ladled water is applied to the heater's rocks, clean them after they have completely cooled. Soak them in a soapy (light detergent) mixture of warm water. Wash off with a sponge, then rinse in clean water. Allow the rocks to dry, then re-apply rocks to the heater trough. Clean the heater and trough of the foreign substance. Gradually build heat in the sauna to totally dry the rocks.

Weekly

Take a rag and soapy water and wipe down benches and heavily used wall areas. (Do not take hose to sauna at any time.) Inspect benches for broken boards, tighten loose screws and make sure benches are firm.

There should be a thermometer/hygrometer in the sauna room at all times to show temperature and humidity for members safety.

Every 6 months-one year (Depending on usage)

Take an orbital sander and lightly sand benches and walls to take off thin layer of discolored wood. Directly after use Scandia Essential Wood Oil and apply to sanded area. Wood oil comes in gallon jugs and can be purchased through Scandia's website.

18

HEATER CARE

Weekly

Remove and inspect all stones and clean the trough. If a stone is broken throw it away. If broken stones are allowed to remain in the trough they will break down into a sandy grit. That grit will eat a hole in the stainless steel. This damage is not covered by the warranty.

Monthly

Wipe down the heater shell to clean up any water stains.

NEVER EVER TURN A HOSE ON THE SAUNA TO WASH IT DOWN.
IT WILL DAMAGE THE HEATER'S ELECTRIC COMPONENTS.

TROUBLESHOOTING GUIDELINES-GAS FIRED HEATERS

Sauna heater is not turning on:

1. Check to make sure timer and thermostat are turned on.
2. Make sure the controls were connected to the burner (gas valve) using the millivolt wire provided.
3. Make sure the correct type of gas was connected (LP or NAT). Burner has been built according to the Gas Heater Order Form supplied by customer.
4. Make sure that there is no crimp in the millivolt wire line that may have happened during installation
5. Make sure the gas is on.
6. Test continuity on switches (timer, stat & hi-limit).

For standing pilot models only:

19

- Pilot light is not lighting up:
 1. Check to make sure pilot has not moved from original place during burner install.
 2. Make sure gas is flowing through copper tubing and there are no leaks.

For Piezo style burners:

- Pilot light is not lighting up:
 1. Check batteries in the battery pack.
 2. Check the gas tank (just for LP burners).
 3. Check the prongs of the pilot generator itself. Clean the prongs with a wire brush if they are dirty to restore it. They may need to be cleaned from time to time. If the prongs are broken, you need a new pilot.

Heater is not getting up to temperature:

1. Check thermostat, make sure thermostat is in the recommended location and position in the sauna room.
2. Check venting:
 - a. For vertical venting, a power vent may be required for run longer than 7 feet.
 - b. Make sure flue cap and or drafthood/elbow have been installed accordingly, depending on your heater model.
 - c. Ensure heat is not exhausting the heater too quickly.

Hi-Limit Switch is tripping

1. Make sure flue cap and or drafthood/elbow have been installed accordingly, depending on your heater model.
2. Make sure air intake of heater has sufficient air supply/flow.
3. Ensure room itself is properly constructed per installation instructions (i.e. framed, insulated, wood walls, ceiling height, etc.)
4. Check gas pressure and adjust as needed.

20

Pilot is lit but burner will not engage.

1. Ensure pilot is properly positioned over burner assembly (standing)
2. Ensure pilot sensors are clean and in the right position.
3. Ensure switches have continuity and are sending the signal back to the gas valve.

How the Heater Works

The heater is designed to draw cool air in through the body of the heater, which is then heated as the burner heats the body of the heater. This heats up the room. The heat is retained inside the heater with baffles that are welded in place and reduce the air flow, and inside the sauna rocks. Too much air flow will result in the heater not properly heating the room, while not enough air flow will cause the heater to get hot and trip the safety hi-limit switch.

All venting should be done by your local plumber or HVAC technician and should follow any city, country, state and local codes.

GAS HEATERS AND BURNER MAINTENANCE GUIDELINES

Make sure you have a gas professional inspect the heater regularly or at least once a year if the heater is in a remote location and not used frequently. The prongs on the pilot generator may need to be cleaned from time to time. At least once a month, clean the rock tray by removing the rocks and wiping down any debris, broken rocks or sand from broken rocks.

For additional technical assistance, please send us your technical ticket attached via e-mail info@scandiamfg.com or via our website www.scandiamfg.com



AM~FINN

1-800-237-2862

design@am-finn.com

am-finn.com